

DATA SHEET

TBA120U

Sound I.F. amplifier/demodulator
for TV

Product specification
File under Integrated Circuits, IC02

March 1986

Sound I.F. amplifier/demodulator for TV**TBA120U****GENERAL DESCRIPTION**

The TBA120U is an i.f. amplifier with a symmetrical FM demodulator and an a.f. amplifier with adjustable output voltage. The a.f. amplifier is also provided with an output for volume control and an input for VCR operation.

The input and output of the TBA120U are especially designed for LC-circuits, but the input can also be used with a ceramic filter.

QUICK REFERENCE DATA

Supply voltage (pin 11)	V_p	typ.	12	V
Supply current	I_p	typ.	13,5	mA
I.F. voltage gain at $f = 5,5$ MHz	$G_{v\text{ if}}$	typ.	68	dB
Input voltage starting limiting	V_i	typ.	30	μV
AM suppression at $\Delta f = \pm 50$ kHz	α	typ.	60	dB
A.F. output voltage adjustment range (pin 8)	$\Delta V_{o\text{ af}}$	typ.	85	dB
A.F. output voltage at $\Delta f = \pm 50$ KHz (r.m.s. value)				
at pin 8	$V_{o\text{ af (rms)}}$	typ.	1,2	V
at pin 12	$V_{o\text{ af (rms)}}$	typ.	1,0	V

PACKAGE OUTLINE

14-lead DIL; plastic (SOT27); SOT27-1; 1996 November 19.

Sound I.F. amplifier/demodulator for TV

TBA120U

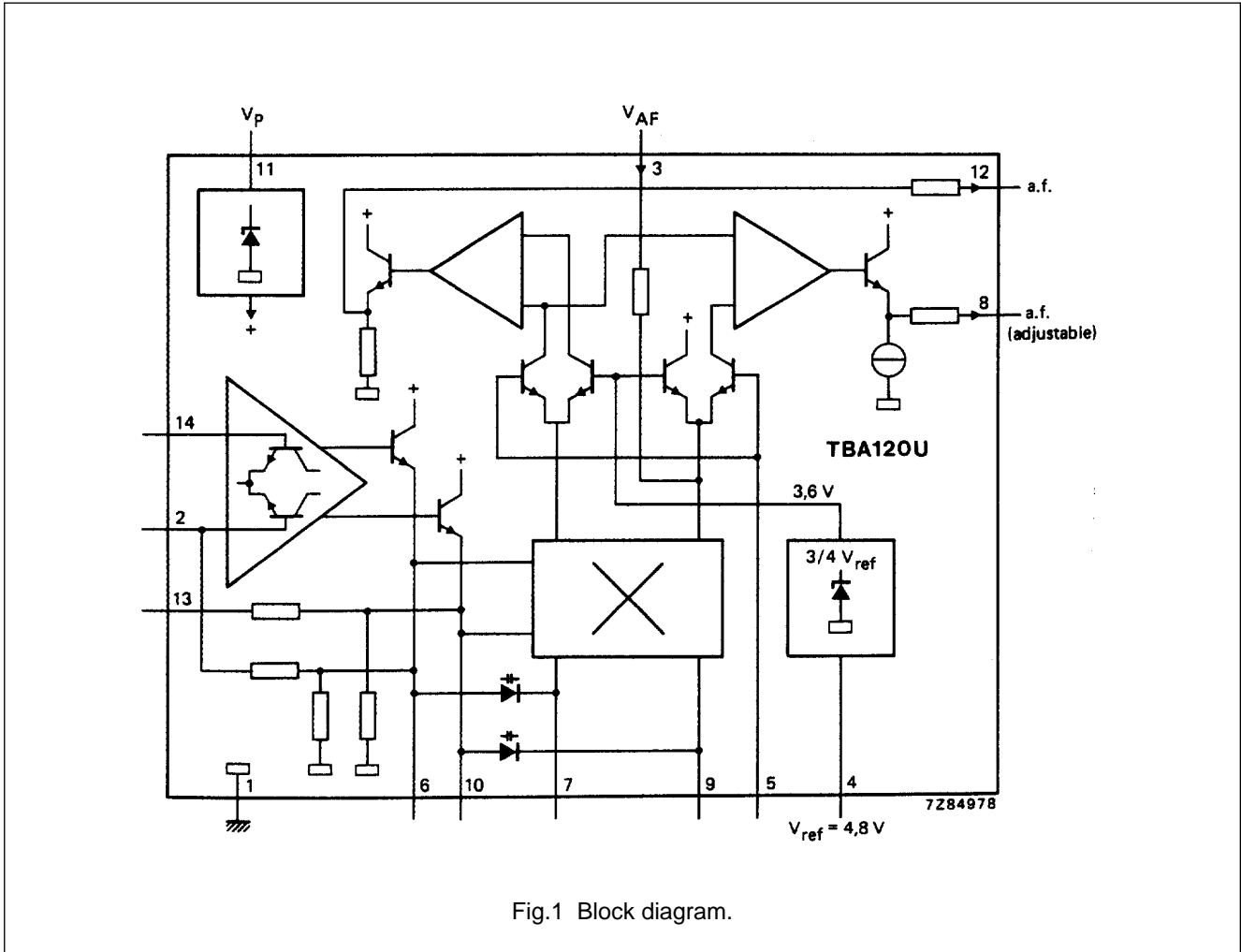

Fig.1 Block diagram.

Sound I.F. amplifier/demodulator for TV

TBA120U

RATINGS

Limiting values in accordance with the Absolute Maximum System (IEC 134)

Supply voltage (pin 11)	$V_P = V_{11-1}$	max.	18	V ⁽¹⁾
Adjustment voltage (pin 5)	V_{5-1}	max.	6	V
Total power dissipation	P_{tot}	max.	400	mW
By-pass resistance	R_{13-14}	max.	1	k Ω
Storage temperature range	T_{stg}		-40 to + 125	$^{\circ}\text{C}$
Operating ambient temperature range	T_{amb}		0 to + 70	$^{\circ}\text{C}$

CHARACTERISTICS $V_P = 12\text{ V}$; $T_{amb} = 25\text{ }^{\circ}\text{C}$; $f = 5,5\text{ MHz}$

I.F. voltage gain	$G_{v\text{ if } 6-14}$	typ.	68	dB
Input voltage starting limiting at $\Delta f = \pm 50\text{ kHz}$; $f_m = 1\text{ kHz}$	V_i	typ.	30	μV
		<	60	μV
I.F. output voltage at limiting (peak-to-peak value)	$V_o\text{ if (p-p)}$	typ.	250	mV
AM suppression at $\Delta f = \pm 50\text{ kHz}$; $V_i = 500\text{ }\mu\text{V}$; $f_m = 1\text{ kHz}$; $m = 30\%$	α	>	50	dB
		typ.	60	dB
I.F. residual voltage without de-emphasis at pin 12	$V_{\text{if } 12}$	typ.	30	mV
at pin 8	$V_{\text{if } 8}$	typ.	20	mV
A.F. voltage gain	$G_{v\text{ af } 8-3}$	typ.	7,5	
A.F. adjustment at $R_{4-5} = 5\text{ k}\Omega$; $R_{5-1} = 13\text{ k}\Omega$			20 to 36	dB
A.F. output voltage control range	$\Delta V_{o\text{ af}}$	typ.	28	dB
		>	70	dB
		typ.	85	dB
Adjustment resistor(note 2)	R_{4-5}		1 to 10	k Ω
D.C. voltage portion at the a.f. outputs pin 12	V_{12-1}	typ.	5,6	V
pin 8	V_{8-1}	typ.	4,0	V
Output resistance of the a.f. outputs pin 12	$R_{o\text{ } 12-1}$	typ.	1,1	k Ω
pin 8	$R_{o\text{ } 8-1}$	typ.	1,1	k Ω
Input resistance of the a.f. input	$R_{i\text{ } 3-1}$	typ.	2	k Ω
			4,2 to 5,3	V
Stabilized reference voltage	$V_{4-1} = V_{ref}$	typ.	4,8	V
Source resistance of reference voltage source	R_{4-1}	typ.	12	Ω

Sound I.F. amplifier/demodulator for TV

TBA120U

Hum suppression

at pin 12	V_{12}/V_{11}	typ.	30	dB
at pin 8	V_8/V_{11}	typ.	35	dB
Supply current (pin 11)	$I_P = I_{11}$		9,5 to 17,5	mA
		typ.	13,5	mA
I.F. input impedance	$ Z_i $	typ.	40 k Ω /4,5	pF
		>	15 k Ω / < 6	pF

A.F. output voltage at $\Delta f = \pm 50$ kHz; $f_m = 1$ kHz;

$V_i = 10$ mV; $Q_o = 45$; r.m.s. value

at pin 12	$V_{o\ af\ (rms)}$	typ.	1,0	V
at pin 8	$V_{o\ af\ (rms)}$	typ.	1,2	V

Distortion at $\Delta f = \pm 50$ kHz; $f_m = 1$ kHz;

$V_i = 10$ mV; $Q_o = 20$

d_{tot}	typ.	1	%
-----------	------	---	---

Notes

1. Supply voltage operating range is 10 to 18 V.
2. Pin 5 must be connected to pin 4, when volume control adjustment is not applicable.

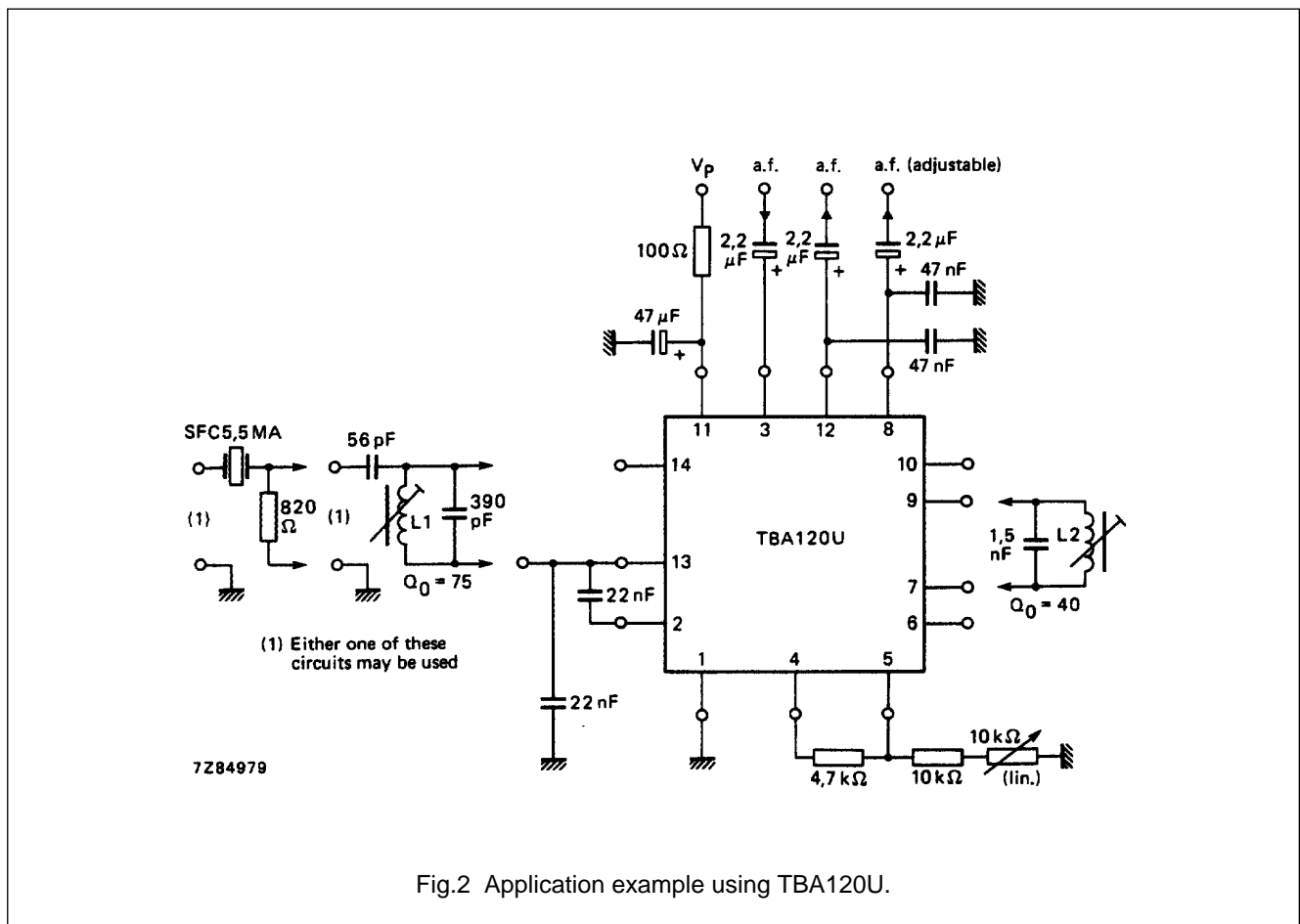

Fig.2 Application example using TBA120U.

Sound I.F. amplifier/demodulator for TV

TBA120U

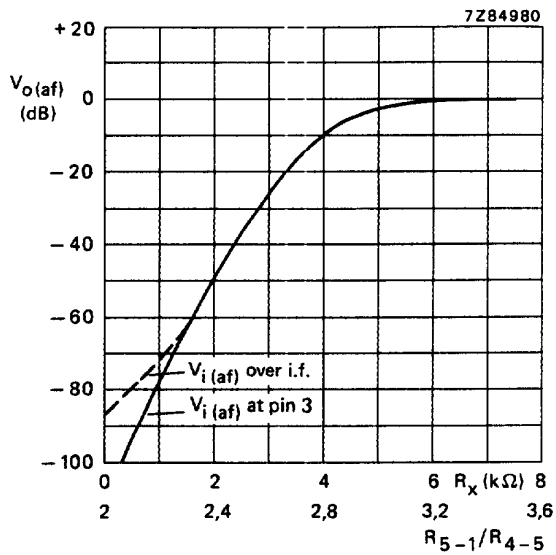

Fig.3 The a.f. output voltage at pin 8 as a function of the resistance values as shown in Fig.4.

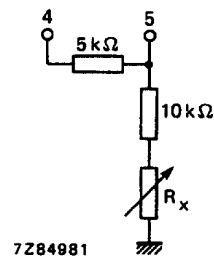
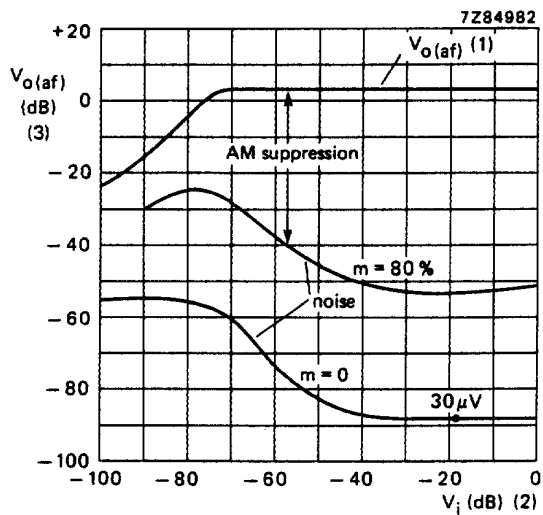
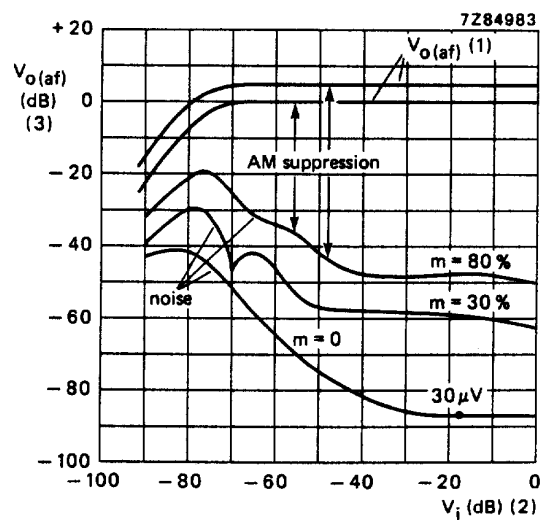

Fig.4 Resistor conditions for curves in Fig.3.



- (1) $V_{o\text{af}}$ with de-emphasis at $\Delta f = \pm 50$ kHz; $f_m = 1$ kHz; $d_{\text{tot}} = 1,5\%$; $0\text{ dB} \cong 770$ mV.
- (2) V_i : $0\text{ dB} \cong 200$ mV at 60 Ω .

Fig.5 The a.f. output voltage at pin 8 as a function of the input voltage with SFC 5,5 MA at the input (see Fig.2).



- (1) $V_{o\text{af}}$ with de-emphasis at $f_m = 1$ kHz; $0\text{ dB} \cong 770$ mV; curve a: $\Delta f = \pm 50$ kHz; $d_{\text{tot}} = 3\%$; curve b: $\Delta f = \pm 25$ kHz; $d_{\text{tot}} = 1\%$.
- (2) V_i : $0\text{ dB} \cong 200$ mV at pin 14.

Fig.6 The a.f. output voltage at pin 8 as a function of the input voltage with broadband input (60 Ω).

Sound I.F. amplifier/demodulator for TV

TBA120U

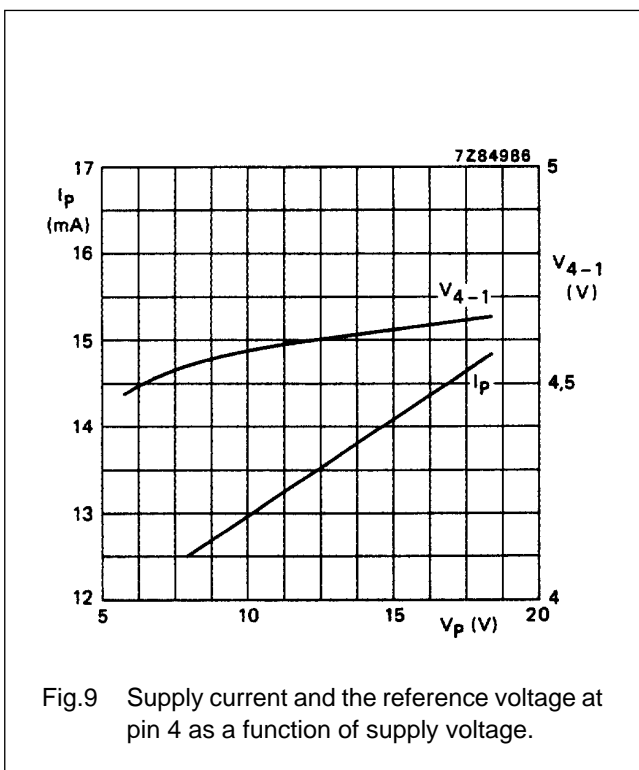
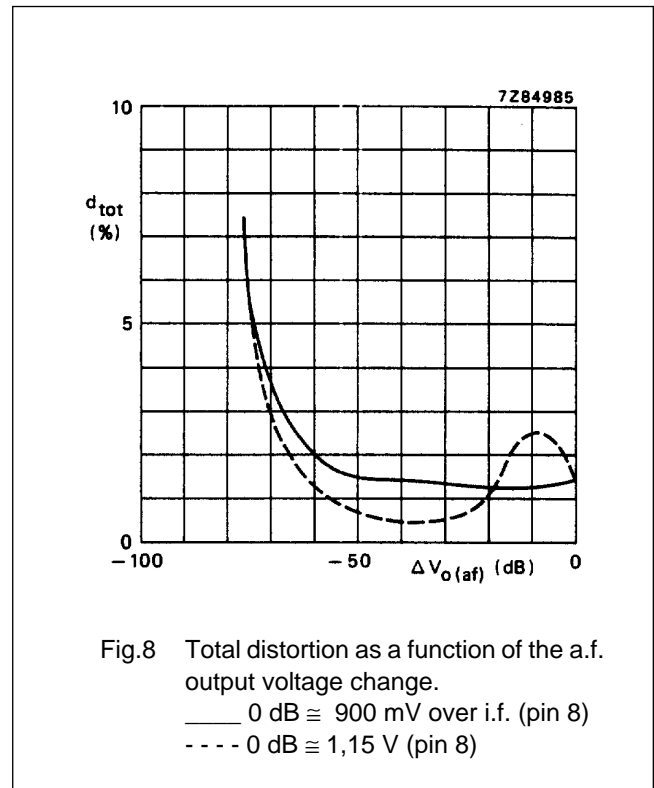
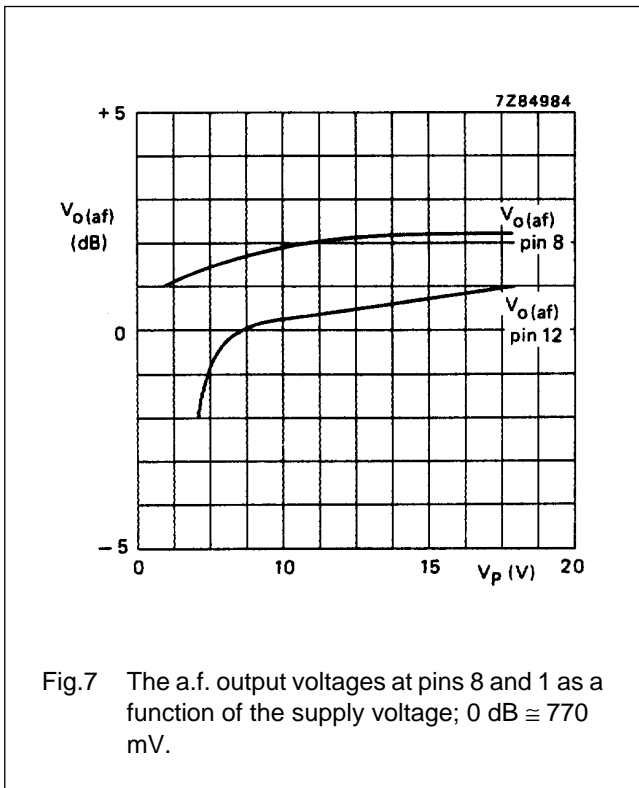

Sound I.F. amplifier/demodulator for TV

TBA120U

PACKAGE OUTLINE

DIP14: plastic dual in-line package; 14 leads (300 mil)

SOT27-1

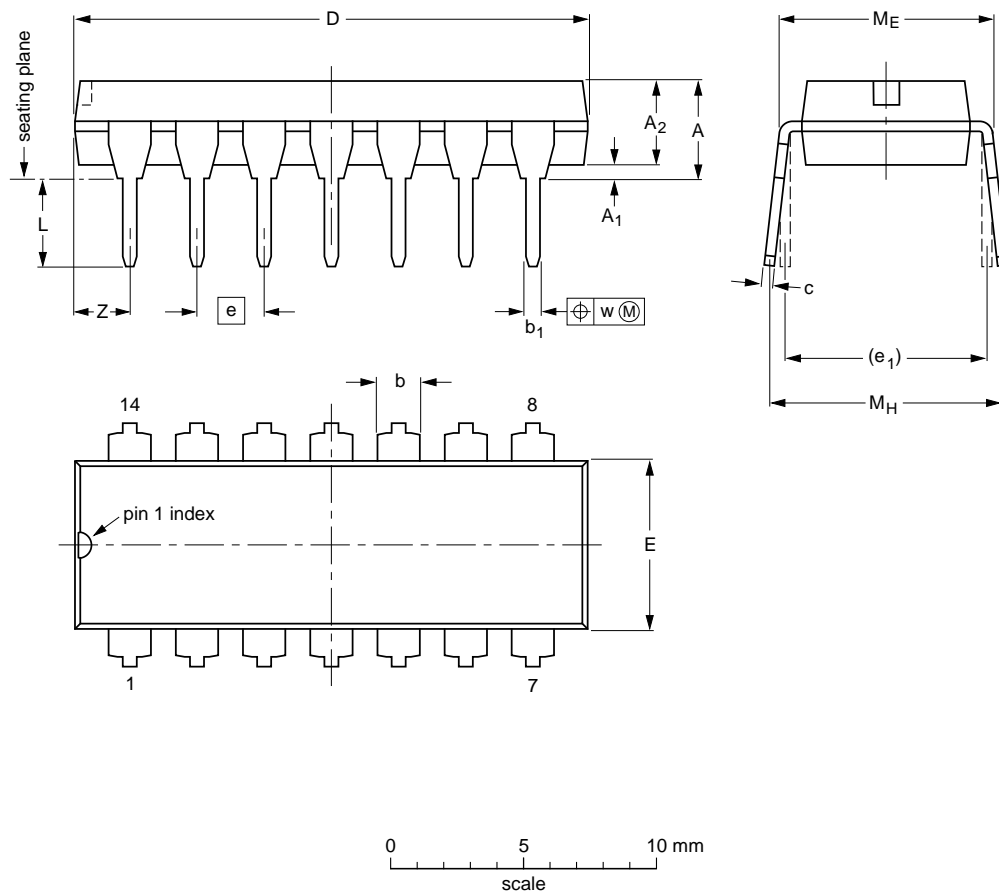

DIMENSIONS (inch dimensions are derived from the original mm dimensions)

UNIT	A max.	A ₁ min.	A ₂ max.	b	b ₁	c	D ⁽¹⁾	E ⁽¹⁾	e	e ₁	L	M _E	M _H	w	Z ⁽¹⁾ max.
mm	4.2	0.51	3.2	1.73 1.13	0.53 0.38	0.36 0.23	19.50 18.55	6.48 6.20	2.54	7.62	3.60 3.05	8.25 7.80	10.0 8.3	0.254	2.2
inches	0.17	0.020	0.13	0.068 0.044	0.021 0.015	0.014 0.009	0.77 0.73	0.26 0.24	0.10	0.30	0.14 0.12	0.32 0.31	0.39 0.33	0.01	0.087

Note

1. Plastic or metal protrusions of 0.25 mm maximum per side are not included.

OUTLINE VERSION	REFERENCES				EUROPEAN PROJECTION	ISSUE DATE
	IEC	JEDEC	EIAJ			
SOT27-1	050G04	MO-001AA				92-11-17 95-03-11

Sound I.F. amplifier/demodulator for TV

TBA120U

SOLDERING

Introduction

There is no soldering method that is ideal for all IC packages. Wave soldering is often preferred when through-hole and surface mounted components are mixed on one printed-circuit board. However, wave soldering is not always suitable for surface mounted ICs, or for printed-circuits with high population densities. In these situations reflow soldering is often used.

This text gives a very brief insight to a complex technology. A more in-depth account of soldering ICs can be found in our "IC Package Databook" (order code 9398 652 90011).

Soldering by dipping or by wave

The maximum permissible temperature of the solder is 260 °C; solder at this temperature must not be in contact with the joint for more than 5 seconds. The total contact time of successive solder waves must not exceed 5 seconds.

The device may be mounted up to the seating plane, but the temperature of the plastic body must not exceed the specified maximum storage temperature ($T_{stg\ max}$). If the printed-circuit board has been pre-heated, forced cooling may be necessary immediately after soldering to keep the temperature within the permissible limit.

Repairing soldered joints

Apply a low voltage soldering iron (less than 24 V) to the lead(s) of the package, below the seating plane or not more than 2 mm above it. If the temperature of the soldering iron bit is less than 300 °C it may remain in contact for up to 10 seconds. If the bit temperature is between 300 and 400 °C, contact may be up to 5 seconds.

DEFINITIONS

Data sheet status	
Objective specification	This data sheet contains target or goal specifications for product development.
Preliminary specification	This data sheet contains preliminary data; supplementary data may be published later.
Product specification	This data sheet contains final product specifications.
Short-form specification	The data in this specification is extracted from a full data sheet with the same type number and title. For detailed information see the relevant data sheet or data handbook.
Limiting values	
Limiting values given are in accordance with the Absolute Maximum Rating System (IEC 134). Stress above one or more of the limiting values may cause permanent damage to the device. These are stress ratings only and operation of the device at these or at any other conditions above those given in the Characteristics sections of the specification is not implied. Exposure to limiting values for extended periods may affect device reliability.	
Application information	
Where application information is given, it is advisory and does not form part of the specification.	

LIFE SUPPORT APPLICATIONS

These products are not designed for use in life support appliances, devices, or systems where malfunction of these products can reasonably be expected to result in personal injury. Philips customers using or selling these products for use in such applications do so at their own risk and agree to fully indemnify Philips for any damages resulting from such improper use or sale.